



USER'S GUIDE

3-in-1 light & sound nursery air purifier Hubble Pure

The Features described in this user's guide are subject to modifications without prior notice.

Welcome...

to your new Hubble Air Purifier!

Thank you for purchasing your new Hubble Air Purifier!

Keeping the air clean in your nursery is essential to your baby's health. The Hubble Light & Sound Air Purifier is an essential item to have in your home. This 3-in-1 air purifier keeps the air clean while also providing soothing solutions, for your little one.

The air purifier filters has an advanced filtration system – true HEPA filter and high-efficiency activated carbon filter- that filters out airborne allergens, pet hair, dander, smoke, mold, odors and large dust particles to ensure your baby is breathing easily and safely. Additionally, it removes 99.97% of airborne contaminants as small as 0.3 microns.

Help your baby fall asleep or keep them entertained. Connect your phone via Bluetooth and play a lullaby or audiobook for your little one, on the high-quality speaker.

Choose from 7 different night light colors to soothe your baby in the dark. The night light also provides guidance, during late night feeding and diaper changes, without having to turn on the harsh, aggressive bedroom lights.

Please keep your original dated sales receipt for your records. For warranty service of your Hubble product, you will need to provide a copy of your dated sales receipt to confirm warranty status.

Registration is not required for warranty coverage. For product related questions, please call:

Live Chat: hubbleconnected.com

Email: support@hubbleconnected.com

Visit **support.hubbleconnected.com** to download the User Guide with instructions, answers to frequently asked questions, and more to help you get the most from your product.

Inside the Box

- 1 x Air Purifier
- 1 x Activated Carbon Composite True HEPA Filter
- 1 x Power adaptor
- 1 x Quick Start Guide

Overview of the Air Purifier

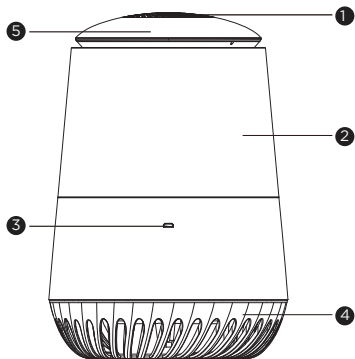

1. Speaker
2. Night Light Cover
3. Micro-USB power socket
4. Bottom cover (HEPA filter compartment access)
5. Touch Control Panel





Functions	Descriptions
 On/Off key	Toggle to power on (Blue key backlit) and power off (Red key backlit).
 Fan Speed key	Tap to select fan speeds: Low (low Blue key backlit); Middle (moderate Blue key backlit); High (bright blue key backlit).
 Night Light key	Blue key backlit: 7 Night Light colors plays in cyclic, tap once the button to confirm the color selection, long press for 3s to switch off the Night Light.
 Sleep On key	Tap to enter Sleep On mode: Backlit key LED turns to dim blue, the Fan speed is locked at low speed and Night Light will be off. Tap twice to switch off the Sleep On mode.

Table of contents

1. Safety Instructions	5
2. Getting Started	7
2.1 Install HEPA filter for your Air Purifier	7
2.2 Connect Air Purifier to Power Supply	7
3. Recommendations for Use and Care	8
4. Operations	9
4.1 Power on/off	9
4.2 Fan speed selection	9
4.3 Sleep On mode selection	9
4.4 Night Light Setting	10
4.5 Bluetooth Audio Streaming	10
5. Dismantle and cleaning of Night Light Cover	11
6. Checking and Maintaining the Filter	13
7. Troubleshooting	15
8. Disposal of the Device (environment)	16
9. General Information	17
10. Technical Specifications	22



1. Safety Instructions

READ AND SAVE THESE INSTRUCTIONS.

WARNING

This product is compliant with all relevant electromagnetic field standards and is, when handled as described in the User's Guide, safe to use. Therefore, always read the instructions in this User's Guide carefully before using the device and save it for later use.

- This product is not a toy. Do not allow children to play with it.
- The air purifier is intended for indoor use only. Do not operate the air purifier outdoors.
- Make sure that all filters are properly installed before you switch on the unit.
- Always turn the appliance off before unplugging it.
- Always disconnect the unit by unplugging it from the electrical outlet before moving or cleaning the unit, opening the grill, changing the filters and whenever the unit is not in use.
- To disconnect the unit, be sure to pull the plug and not the cord.
- Plug the appliance directly into an electrical outlet.
- Keep the cord out of heavy traffic areas.
- To avoid fire hazard, NEVER put the cord under rugs, near heat registers, radiators, stoves, or heaters.
- To protect against electrical hazards, DO NOT immerse the appliance in water or other liquids. Do not use near water.
- This appliance can be used by children aged from 8 years and above and persons with reduced physical, sensory or mental capabilities or lack of experience and knowledge if they have been given supervision or instruction concerning use of the appliance in a safe way and understand the hazards involved.
- Cleaning and user maintenance shall not be performed by children without supervision.
- Appliance that are obviously damaged must not be operated.
- If the supply cord is damaged, it must be replaced by the manufacturer, its service agent or similarly qualified persons in order to avoid hazard.



- DO NOT attempt to repair or adjust any electrical or mechanical functions on this unit. Doing so will void your warranty. The inside of the unit contains no user serviceable parts. All servicing should be performed by the manufacturer or its service agent.
- Place the air purifier on a smooth, level surface, such as a table.
- NEVER place the appliance on a soft surface, such as a bed or sofa, as this could cause the unit to tip over and block the air inlet or outlet grills.
- Do NOT place anything on top of the unit.
- NEVER drop or insert any objects into the air inlet and outlet of the unit.
- Do NOT run cord under carpeting.
- Always handle the air purifier with dry hands to avoid electric shock.
- Do NOT use this appliance when you have used indoor smoke type insect repellents or in places with oil residues, burning incense, or chemical fumes.
- Do NOT use the appliance in a room with major temperature changes, as this may cause condensation inside the appliance.
- Do NOT use the appliance in wet surroundings with high ambient temperatures, such as the bathroom, toilet, or kitchen.
- Do NOT place the appliance directly below an air conditioner to prevent condensation from dripping onto the appliance.
- Keep the appliance away from heated surfaces and open flames.
- To prevent interference, place the appliance at least 2 m (6.6 feet) away from electrical appliances that use airborne radio waves such as TVs, radios, and radio-controlled clocks.
- Do NOT use gasoline, benzene, thinner, harsh cleaners, etc. on and/or in the unit while cleaning as they will damage the product.
- NEVER use alcohol or other solvents.
- The unit is only intended for household use as described in this User's Guide. Any other use not recommended by the manufacturer may cause fire, electric shock or injury to persons.
- Keep this User's Guide for future reference.

Important guidelines for installing Air Purifier

- Use of other 2.4 GHz products, such as other wireless networks or microwave ovens may cause interference with this product. Keep the Air Purifier away from these types of products, or turn them off if they appear to be causing interference.



2. Getting Started

2.1 Install HEPA filter for your Air Purifier

- Take the HEPA filter out from polybag.
- Follow the UNLOCK mark  to to loose the bottom cover (Fig. 1).
- Put back the HEPA filter into the compartment (Fig. 2).
- Replace the bottom cover then rotate to lock (Fig. 3).
- Place the unit back to upright position.



fig 1

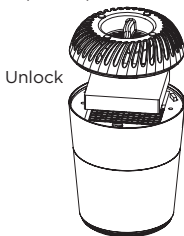



fig 2



fig 3

2.2 Connect Air Purifier to Power Supply

- Connect the micro-USB plug of the power adaptor to the air purifier and the other end to the electrical outlet.
- Use only the enclosed power adaptor (5VDC 2A).
- The  button will light up momentarily and the backlight will stay on for 5s then goes off. It will light up again when you tap to turn on the Air Purifier.

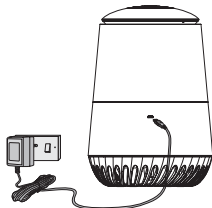

3. Recommendations for Use and Care

- The appliance is only intended for household use as described in this manual. Any other use not recommended by the manufacturer may cause fire, electric shock or injury to persons.
- During operation, NEVER block the air openings, grills/ outlets of the unit or place the unit on a soft surface such as a bed or sofa, as this could cause the unit to tip over, blocking the air inlet or outlet openings.
- Before replacing the true-HEPA filter, make sure that you unplug the air purifier from the electrical outlet in order to prevent electric shock.
- Use a clean, dry, soft cloth to wipe the external surface of the unit.
- Do NOT let the area around the air purifier to become damp or wet. Please do NOT immerse the device into water or other liquids in order to prevent electrical hazards.
- Clean the air purifier according to instructions when the product will not be in frequent use. Before storage, make sure that all the parts are clean and dry. Store the air purifier in a dry place. After storage, clean the air purifier again and remove any dust on the outside.
- Please do NOT operate the appliance with a damaged cord or plug. If the motor fan fails to rotate, OR if the device has been dropped or damaged in any manner, leading to appliance malfunction, DO NOT operate it to prevent risks of harm or injury.
- The unit may cause interference to other nearby 2.4 GHz products, such as other wireless networks Bluetooth systems or microwave ovens during operation. Keep the air purifier away from these types of products, or turn them off if there is interference.
- Every effort has been made to ensure high standards of reliability of your air purifier. However, if something does go wrong, please do not try to repair it yourself - contact Customer Service for assistance.



4. Operations

4.1 Power on/off

Tap once on  button to power on (backlit turns blue) or to power off (backlit turns red). When first power up, the unit operates automatically at middle fan speed and ionizer operates simultaneously.

When first power up, the Bluetooth audio streaming function enters pairing mode, use Bluetooth-enabled mobile phone to scan for (device "Hubble Pure") and complete the pairing.

4.2 Fan speed selection

Touch once the  button to select 3 fan speeds:

- Low (low blue backlit)
- Middle (dim blue backlit)
- High (bright blue backlit)

4.3 Sleep On mode selection



The device is featured with Sleep mode function helping baby to fall into sleep. Toggle the  button to program sleep mode on/off. When Sleep On mode is selected, the device runs with LOW fan speed, button backlit OFF and BLUE night light.

Tap once any button at this state will switch off the sleep mode setting temporarily, the unit will return to Sleep On mode again if no key action within 3 seconds. To switch off the function, tap twice any button on the control panel.



4.4 Night Light Setting

The device gives 7-night light colors for selection.

Key press	Action	Button backlit indication
First power up	Auto cyclic mode (or color selection mode)	Bright blue
Tap 1st time the  button	Stop to select the desired night light at auto cyclic.	Dim blue
Tap 2nd time the  button	Switch to steady white color.	Amber
Tap 3rd time the  button	Repeat the auto cyclic mode (or color selection mode) and subsequent key actions.	Bright blue

Note: Long press 3s on  button to switch off the Night Light.

4.5 Bluetooth Audio Streaming

When the unit is first powered up, the unit enters Bluetooth pairing mode once the unit detects registered Bluetooth-enabled device, they will re-connect. You need to connect with Bluetooth each time the unit is powered off and on.

Note:

If the unit is already connected with an electronic device, the Bluetooth speaker is unable to connect / pair with a third one without switching off the already paired device.



5. Dismantle and cleaning of Night Light Cover

The dust will likely stay on the inside surface of the clear Night Light Cover after period of use. It is detachable for cleaning. Disconnect the power from the electrical outlet then follow the steps below.

1. Hold the Night Light Cover on opposite sides. Follow the “open” marking to turn the cover in counter-clockwise until the catches are released.

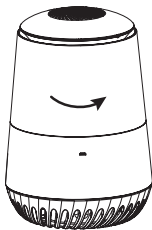

2. Pull the Cover up until it leaves the main body completely.

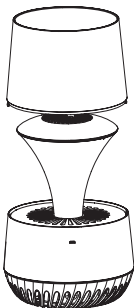

3. After cleaning is done, move the cover back to the original position.

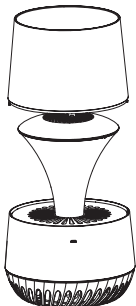

4. Make sure the cover sits properly on the main body. Follow the "close" mark to turn clockwise the cover until the catches lock.

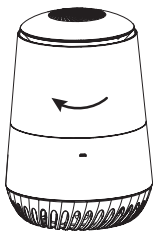

Importance:

- Wipe the dusts and dirt with detergent slightly moistened cloth or use water to clean once a month
- Re-assemble the unit only after all parts are completely dry
- Use dilute neutral detergent to do the cleaning.
- Never use abrasive, aggressive, or flammable cleaning agents such as bleach or alcohol to clean any part of the appliance. Otherwise, it will cause discoloration or deformation.



6. Checking and Maintaining the Filter

- Maintain the Activated Carbon Composite HEPA Filter by checking it frequently.
 - When the filter turns from white to gray or black, it should be replaced.
 - Depending on the air quality conditions, you may need to replace it more frequently. The recommended replacement frequency for normal use is every 6-month of use. Below are the steps of filter replacement:
1. Turn the unit with the bottom facing up then follow the UNLOCK mark to turn to release the bottom cover.

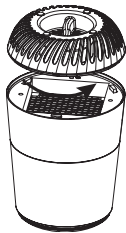

2. Remove the bottom cover.

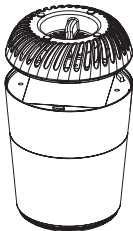

3. Take the Filter (square in shape) out from the compartment with the assistance of ribbons. Replace with new filter in the correct orientation and position.

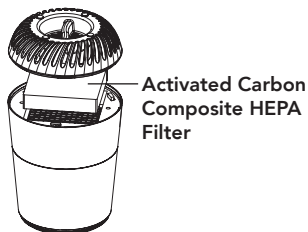

4. Put the bottom cover back to the unit and turn in a clockwise direction to the position marked with a LOCK mark.

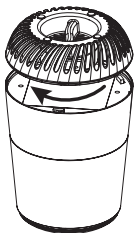

IMPORTANT:

Do NOT attempt to wash and re-use the combination filter. Please contact service at Live Chat: hubbleconnected.com or visit our website: support.hubbleconnected.com to purchase a replacement filter.

NOTE:

The True HEPA and Activated Carbon Filter are combined as a single filter unit. The multi layers include the True HEPA/Activated Carbon filter.



7. Troubleshooting

Issues	Solution
The unit not operate.	<ol style="list-style-type: none"> 1. Please check and make sure that the unit is properly plugged in and the power outlet is energized. 2. Please make sure that the unit has been turned ON. 3. Please check and make sure that the filter is properly installed and the rear grill is seated correctly.
The airflow that comes out of the air outlet is significantly weaker than before.	<ol style="list-style-type: none"> 1. Please make sure that nothing is blocking the air inlet and filtered air outlets. 2. Please check the filter condition and replace it if necessary. Recommended to replace the Activated Carbon/HEPA filter every 6-month of use. 3. Please check if you have removed all packaging material.
Why I hear excessive noise during device operation?	<ol style="list-style-type: none"> 1. Please check and make sure that the parts are firmly positioned in place. 2. Please check if you have removed all the packaging material from the HEPA filter.
Why is the night light continuously blinking?	Installation The bottom cover doesn't seem to fit with the main unit. Make sure that the bottom cover is at the LOCK position.
Power indication light off; does not work	No power supply Connect the unit to power supply and switch on.



8. Disposal of the Device (environment)

At the end of the product life cycle, you should not dispose of this product with normal household waste. Take this product to a collection point for the recycling of electrical and electronic equipment. The symbol on the product, user's guide and/or box indicates this.



Some of the product materials can be re-used if you take them to a recycling point. By reusing some parts or raw materials from used products you make an important contribution to the protection of the environment.

Please contact your local authorities in case you need more information on the collection points in your area.



9. General Information

If your product is not working properly, read the Quick Start Guide or the User's Guide of one of the models listed on page 1.

Contact Customer Service:

Live Chat: hubbleconnected.com

Email: support@hubbleconnected.com

Consumer Products and Accessories Limited Warranty ("Warranty")

Thank you for purchasing this Hubble Smart Nursery branded product manufactured by Hubble Baby (HK) Limited ("HUBBLE").

What Does this Limited Warranty Cover?

Subject to the items listed below in the section "What is not Covered" HUBBLE warrants that this Hubble connected branded product ("Product") will be free from defects in material and workmanship under normal use for a period of 1 year from the date of purchase and that any certified accessory ("Accessory") sold for use with this product will be free from defects in materials and workmanship under normal use for a period of 90-days from the date of purchase. This Limited Warranty is your exclusive warranty and is not transferable.

What is not covered?

This Limited Warranty excludes and does not cover:

- Normal deterioration or wear resulting from use;
- Damage caused by or resulting from misuse, abuse, or accident;
- Damage caused by or resulting from improper operation or storage;
- Damage caused by or resulting from contact with foreign substances, including, but not limited to, liquid, water, rain, humidity, perspiration, sand, dirt, and/or food;
- Damage caused by or resulting from the use of Non-Hubble Smart Nursery branded or certified Products or Accessories or other peripheral equipment;



- Damage caused by or resulting from modifications, alterations, tampering, improper installation, or repairs by someone other than Hubble connected, HUBBLE or their authorized representatives;
- Defects, damages, or the failure of Products or Accessories due to any communication service or signal you may subscribe to or use with the Products or Accessories; and,
- Periodic maintenance, repair and replacement of parts due to normal wear and tear.

What Other Limitations Are There?

THIS LIMITED WARRANTY SETS FORTH THE ENTIRE LIABILITY OF HUBBLE AND CONTAINS YOUR SOLE AND EXCLUSIVE REMEDY. OTHER THAN THIS LIMITED WARRANTY, HUBBLE MAKES NO ADDITIONAL REPRESENTATIONS OR WARRANTIES, EXPRESS OR IMPLIED, INCLUDING WARRANTIES OF MERCHANTABILITY OR FITNESS FOR A PARTICULAR PURPOSE. IF YOUR STATE DOES NOT PERMIT THE DISCLAIMER OF WARRANTIES, THEN THE IMPLIED WARRANTY OF MERCHANTABILITY AND FITNESS FOR A PARTICULAR PURPOSE IS LIMITED TO THE DURATION OF THIS LIMITED WARRANTY. REPAIR OR REPLACEMENT IS YOUR SOLE AND EXCLUSIVE REMEDY AGAINST HUBBLE AND Hubble Smart Nursery. IN NO EVENT SHALL HUBBLE OR Hubble Smart Nursery's LIABILITY TO REPAIR OR REPLACE YOUR PRODUCT OR ACCESSORY EXCEED THE ORIGINAL PURCHASE PRICE OF THE PRODUCT AND ACCESSORY AND HUBBLE AND Hubble Smart Nursery's TOTAL LIABILITY FOR DAMAGES ARISING FROM THIS LIMITED WARRANTY SHALL NOT EXCEED THE PRICE YOU PAID FOR THE PRODUCT AND ACCESSORY REGARDLESS OF WHETHER SUCH CLAIM ARISES UNDER CONTRACT, STATUTE, TORT OR OTHERWISE. IN NO EVENT AND UNDER NO CIRCUMSTANCES WILL HUBBLE OR Hubble Smart Nursery BE LIABLE FOR DIRECT, INDIRECT, INCIDENTAL, SPECIAL OR CONSEQUENTIAL DAMAGES OF ANY KIND, OR LOSS OF REVENUE OR PROFITS, LOSS OF BUSINESS, LOSS OF INFORMATION OR OTHER FINANCIAL LOSS ARISING OUT OF OR IN CONNECTION WITH THE ABILITY OR INABILITY TO USE



THE PRODUCTS OR ACCESSORIES. ALL DISCLAIMERS, LIMITATIONS OF LIABILITY AND MODIFICATIONS OF WARRANTIES STILL APPLY EVEN IF THE LIMITED REMEDY OF REPAIR AND REPLACEMENT FAILS OF ITS ESSENTIAL PURPOSE.

Some jurisdictions do not allow the limitation or exclusion of incidental or consequential damages, so the above limitations or exclusions may not apply to you. This Limited Warranty gives you specific legal rights, and you may have other rights that vary from one jurisdiction to another.

Who is covered?

This Warranty extends only to the first consumer purchaser and is not transferable.

What will HUBBLE do?

HUBBLE or its authorized distributor at its sole discretion will, at no charge, repair or replace any Products or Accessories that do not conform to this Warranty. In the event that replacement is necessary to remedy a defect in material or workmanship, HUBBLE may use new or remanufactured products, accessories or parts of equal quality to the original Product or Accessory.

How to Obtain Warranty Service or Other Information?

To obtain service or information, please call:

Live Chat: [hubbleconnected.com](https://www.hubbleconnected.com).

Email: support@hubbleconnected.com

You will receive instructions on how to ship the Products or Accessories at your expense and risk, to a HUBBLE Authorized Repair Center.

You must include: (a) the Product or Accessory; (b) the original proof of purchase (receipt) which includes the date, place and seller of the Product; (c) if a warranty card was included in your box, a completed warranty card showing the serial number of the Product; (d) a written description of the problem; and, (e) your name, address, email address and telephone number.



These terms and conditions constitute the complete warranty agreement between you and HUBBLE regarding the Products or Accessories purchased by you, and supersede any prior agreement or representations, including representations made in any literature publications or promotional materials issued by HUBBLE or representations made by any agent, employee or staff of HUBBLE, that may have been made in connection with your purchase of any Product and/or Accessory.

FCC and IC regulations (FCC Part 15)

This device complies with Part 15 of the FCC Rules. Operation is subject to the following two conditions: (1) this device may not cause harmful interference, and (2) this device must accept any interference received, including interference that may cause undesired operation.

Warning: Changes or modifications to this unit not expressly approved by the party responsible for compliance could void the user's authority to operate the equipment.

NOTE: This equipment has been tested and found to comply with the limits for a Class B digital device, pursuant to Part 15 of the FCC Rules. These limits are designed to provide reasonable protection against harmful interference in a residential installation. This equipment generates, uses and can radiate radio frequency energy and, if not installed and used in accordance with the instructions, may cause harmful interference to radio communications.

However, there is no guarantee that interference will not occur in a particular installation. If this equipment does cause harmful interference to radio or television reception, which can be determined by turning the equipment off and on, the user is encouraged to try to correct the interference by one or more of the following measures:

- Reorient or relocate the receiving antenna.
- Increase the separation between the equipment and receiver.
- Connect the equipment into an outlet on a circuit different from that to which the receiver is connected.
- Consult the dealer or an experienced radio/TV technician for help.



FCC RF Radiation Exposure Statement

Caution: To maintain compliance with the FCC's RF exposure guidelines, place the unit at least 20cm from nearby persons.

This device contains licence-exempt transmitter(s)/receiver(s) that comply with Innovation, Science and Economic Development Canada's licence-exempt RSS(s). Operation is subject to the following two conditions:

- 1. This device may not cause interference.*
- 2. This device must accept any interference, including interference that may cause undesired operation of the device.*

L'émetteur/récepteur exempt de licence contenu dans le présent appareil est conforme aux CNR d'Innovation, Sciences et Développement économique Canada applicables aux appareils radio exempts de licence. L'exploitation est autorisée aux deux conditions suivantes :

- 1. L'appareil ne doit pas produire de brouillage;*
- 2. L'appareil doit accepter tout brouillage radioélectrique subi, même si le brouillage est susceptible d'en compromettre le fonctionnement.*

Download User Guide from website: support.hubbleconnected.com



10. Technical Specifications

Connectivity	Bluetooth 5.0
Standby power consumption	less than 0.5W
Operating Temperature	41 to 104°F (5°C to 40°C)
Power Adaptor	Input: 100-240V AC, 50/60Hz, 300mA; Output: 5.0V DC, 2A WARNING <i>Use only with provided power supply.</i>
Power	Hi-speed 2.6W±0.3W Med-speed 2.0W±0.3W Lo-speed 1.6W±0.3W
Activated Carbon Filter and True HEPA Filter	Yes - replaceable
Noise	20dB ~ 50dB





Manufactured, distributed and sold by Hubble
Baby (HK) Limited. All rights reserved.

US_EN Version 3.0
Printed in China

